

Manual for use and maintenance

RLED 2.0



RLED 2.0

Light Dimmer

Ag/MIS/UmGb-2628-08/18 Rev 1.1

P/N: 116599

 **Munters**

RLED 2.0

Manual for use and maintenance

Document Revision: 1.1, 12/2019

Ag/MIS/UmGb-2628-08/18 Rev 1.7 (MIS)

Software Ver: 1.07

This manual for use and maintenance is an integral part of the apparatus together with the attached technical documentation.

This document is destined for the user of the apparatus: it may not be reproduced in whole or in part, committed to computer memory as a file or delivered to third parties without the prior authorization of the assembler of the system.

Munters reserves the right to effect modifications to the apparatus in accordance with technical and legal developments.

Index

<i>chapter</i>		<i>page</i>
1	INTRODUCTION	4
1.1	Disclaimer	4
1.2	Introduction	4
1.3	Notes	4
2	TECHNICAL DETAILS	5
3	INTRODUCTION TO THE RLED 2.0	6
3.1	Device Description	6
3.2	Abbreviations and Terms	6
3.3	User Interface	7
4	USING THE RLED 2.0	8
4.1	Preliminary Setup Options	8
4.1.1	System Parameter 1 - Minimum Light Calibration (bu)	8
4.1.2	System Parameter 2 - Address (Ad)	9
4.1.3	System Parameter 3 - Ignition Pulse (Pu)	9
4.1.4	System Parameter 4 - Brightness Restriction (Br)	9
4.1.5	System Parameter 5 - Curve (Cn)	9
4.2	Bright Mode	10
4.3	Manual Dim Mode	10
4.4	Auto Mode	10
4.5	Performing a Cold Start	10
5	INSTALLATION	12
5.1	RLED 2.0 Wiring Diagram	12
5.2	Configuring the Channel Levels	14
5.2.1	Using an Analog Output Card	14
5.2.2	Using a Communication Card	15
5.3	Environmental Protection	16
6	TROUBLESHOOTING	17
7	WARRANTY	18

1 Introduction

1.1 Disclaimer

Munters reserves the right to make alterations to specifications, quantities, dimensions etc. for production or other reasons, subsequent to publication. The information contained herein has been prepared by qualified experts within Munters. While we believe the information is accurate and complete, we make no warranty or representation for any particular purposes. The information is offered in good faith and with the understanding that any use of the units or accessories in breach of the directions and warnings in this document is at the sole discretion and risk of the user.

1.2 Introduction

Congratulations on your excellent choice of purchasing an RLED 2.0!

In order to realize the full benefit from this product it is important that it is installed, commissioned and operated correctly. Before installation or using the fan, this manual should be studied carefully. It is also recommended that it is kept safely for future reference. The manual is intended as a reference for installation, commissioning and day-to-day operation of the Munters Controllers.

1.3 Notes

Date of release: July 2010

Munters cannot guarantee to inform users about the changes or to distribute new manuals to them.

All rights reserved. No part of this manual may be reproduced in any manner whatsoever without the expressed written permission of Munters. The contents of this manual are subject to change without notice.

2 Technical Details

Input Power Voltage	One/Two phase, 230 VAC 50/60 Hz
	One phase, 115 VAC 50/60 Hz
Output Maximal Load (Per Channel)	1.8 KVA (max) 230 VAC 50 Hz
	1.1 KVA (max) 115 VAC 60 Hz
0-10 VDC Analog Input Impedance	3.7 K
Operating Temperature Range	0° to +55° C (32° to 130° F)
Humidity	85%
Enclosure	Metal
Fuses	Main fuse: 315 mA slow blow

CAUTION Verify that the RLED 2.0's electrical input is connected to a circuit breaker (see Figure 1).

CAUTION The unit is for indoor use only.

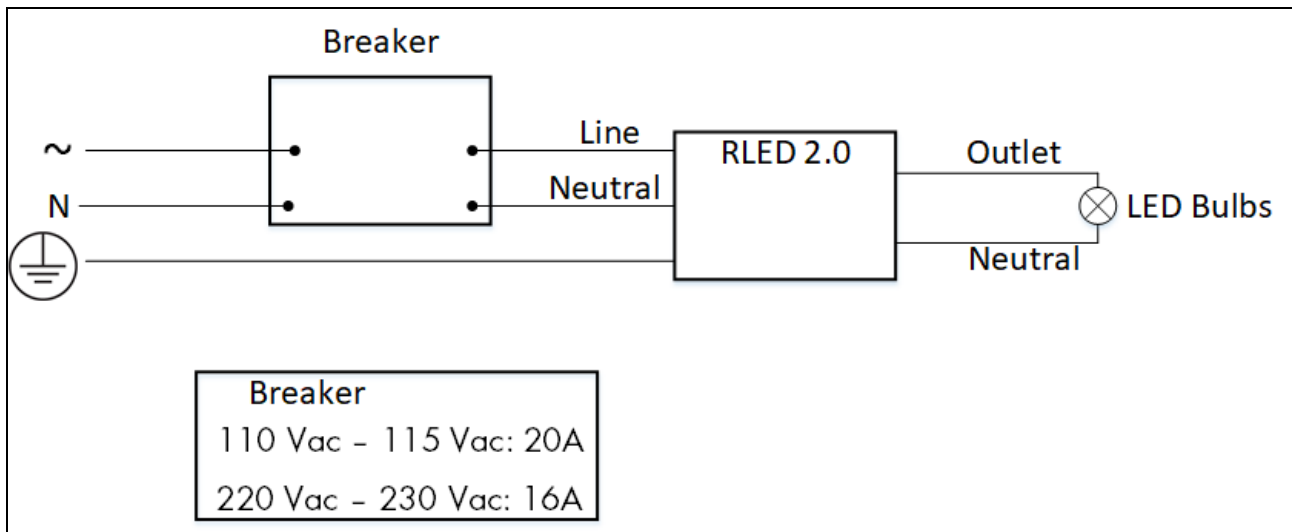

Figure 1: Breaker - RLED wiring

3 Introduction to the RLED 2.0

The RLED 2.0 units enable controlling LED light and brightness in the poultry pen. The Munters Platinum, Platinum Pro, AC-2000, and Super Guard Controllers support the RLED 2.0. This manual is meant to be used by either a poultry farmer or authorized personnel who own a poultry pen.

3.1 Device Description

The RLED 2.0 is a two independent channel device controlling all light functions inside a poultry house. This dimmer has unique features such as stable operation in low brightness levels and high flexibility.

- **Main features:**
 - User defined lighting parameters enable the RLED 2.0 to work with most types of light bulbs
 - Two independent channels*
 - Manual brightness control
 - Provides precise dimming at very low light intensity
 - Eliminates light flickering
 - Programmable brightness control by analog signal 0 - 10 VDC and communication line from the controller
 - **Automatic settings recovery after power failure
 - Automatic settings saved for both A/B channels
 - Maximum light intensity settings
 - Automatic shutdown timer

*NOTE **While RLED 2.0 can support most type of bulbs, Munters recommends that in any given line (channel) only one type of bulb be used.*

*NOTE **The settings are immediately saved after being defined.*

3.2 Abbreviations and Terms

Abbreviations/Terms	Meaning Description
Cold Start	The procedure that restores default (factory) parameter values. Refer to Performing a Cold Start, page 10.
"bu"	Bulb: This parameter defines the light bulb's minimum lighting level. Refer to System Parameter 1 - Minimum Light Calibration (bu), page 8.
"Ad"	Address: This parameter defines the number of communication lines between the RLED and the controllers. Refer to System Parameter 2 - Address (Ad), page 9.

Abbreviations/Terms	Meaning Description
"Pu"	Pu: This parameter sets the light level when going from off to on. When enabled, the ignition pulse causes the lights to briefly shine and then the light goes down to the level defined in the bu parameter. Refer to System Parameter 3 – Ignition Pulse (Pu), page 9.
"br"	Brightness Restriction: This parameter restricts the output lightening upper limit. Its values can be within "On" (100) and "0" (0%). Refer to System Parameter 4 – Brightness Restriction (Br), page 9.
Cn	Curve (refer to System Parameter 5 – Curve (Cn), page 9).

3.3 User Interface

The following section details the keypad.

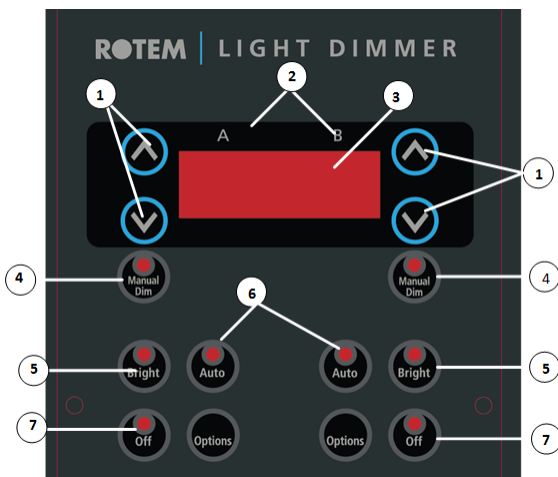

Figure 2: Front Pane

Note that the keypad is divided into two channels ('A' and 'B'), press the appropriate channel buttons. The relevant LED indicates the current active mode.

1. **Arrow keys:** Use these keys to adjust the parameters.
2. **Channels:** RLED 2.0 supports two channels. Note that the buttons are duplicated since each one is dedicated to each channel separately.
3. **Display:** Displays the RLED 2.0 parameters.
4. **Manual Dim:** Pressing this button sets the RLED 2.0 channel to manual mode. In manual mode set the light level using the arrow keys.
5. **Bright:** Press this button to increase the brightness to the maximum level for 20 minutes. After pressing Bright the display shows the lightening level as it rises to the defined maximum. Once that level is reached, the display then shows the remaining amount of time before the light begins to turn off. When this period ends, the lighting level gradually decreases. Define the maximum brightness level in Bright Mode, page 10.
6. **Auto:** Pressing this button utilizes the analog input card 0-10 V or communication card and is controlled via a controller lighting table program.
7. **Off:** Pressing this button gradually reduces the channel to 0% light intensity.
8. **Options:** Press this button for three seconds to go to the RLED 2.0 system parameters menu.

4 Using the RLED 2.0

The following sections detail how to use the RLED 2.0. After setting the parameters, RLED 2.0 automatically backs them up. In cases when the power shuts down and goes back on, the controller continues operating as in its last saved state.

- Preliminary Setup Options
- Bright Mode
- Manual Dim Mode
- Auto Mode
- Performing a Cold Start

4.1 Preliminary Setup Options

Press Options of either channel for three seconds to enter the system parameters menu. The first parameter is "bu". To navigate to the other parameters, press the Options button. The sequence order of parameters to appear is as follows: bu > Ad > Pu > br > Cn.

NOTE The "Options" button is also used to exit from this menu.

- System Parameter 1 - Minimum Light Calibration (bu)
- System Parameter 2 - Address (Ad)
- System Parameter 3 - Ignition Pulse (Pu)
- System Parameter 4 - Brightness Restriction (Br)
- System Parameter 5 - Curve (Cn)

4.1.1 SYSTEM PARAMETER 1 – MINIMUM LIGHT CALIBRATION (BU)

To use the RLED 2.0 with a light bulb, the user needs to configure the RLED 2.0 to work with that specific bulb. RLED 2.0 enables working with most light bulbs because the user is able to define that bulb's minimum lighting level. The bu parameter defines this parameter. RLED 2.0 defines the level chosen as being 1% of the maximum light level. Any function based on the light level uses this parameter as the basis for any calculation.

➡ RLED 2.0 must be installed and connected to the LEDs.

To calibrate the 1% level:

1. Press **Options** for three seconds. Bu and a number (the pulse width in microseconds) appear.
2. Begin pressing the Up/Down arrow.
 - Pressing the Up arrow causes the number to change by five points.
 - Pressing and holding down the Down arrow causes the number to change by five points.
 - Pressing and quickly releasing the Down arrow causes the number to change by one point.
3. Keep pressing until the light reaches the approximate minimum brightness that you require.
4. Press the Down arrow to fine tune the brightness.

NOTE Munters recommends calibrating the light level every time you install bulbs, in particular if you install LED lights from a different manufacturer.

4.1.2 SYSTEM PARAMETER 2 – ADDRESS (AD)

The "Ad" (address) parameter sets the connection address. The parameter is used to accurately configure communication between the RLED 2.0 and the controllers.

- 0 represents connection via voltage controlled mode using 0-10 VDC analog input
- 1-8 represents connection channels via the controller's communication feature.

1. Press **Options** for three seconds.
2. Go to Ad.
3. Select the connection mode.
 - Connecting via the controller's communication feature: Set the parameter from 1 – 8. Refer to Configuring the Channel Levels, page 14 for further details regarding numbering.

NOTE The unit must be set to Auto Mode when working with a controller (refer to Auto Mode, page 10).

4.1.3 SYSTEM PARAMETER 3 – IGNITION PULSE (PU)

This parameter defines a short burst of electricity sent to the lights when the lights go from off to 1%. The lights will shine briefly and then return to the minimum light level.

1. Press **Options** for three seconds.
2. Go to Pu.
3. Chose the brightness level:
 - Level 0: No pulse ignition
 - Levels 1 (lowest) to 9 (highest)

4.1.4 SYSTEM PARAMETER 4 – BRIGHTNESS RESTRICTION (BR)

This parameter restricts the maximal value of brightness according to the user's setting. The default value is "On" (100%). Adjust the desired limit through use of the "UP" and "DOWN" buttons. This feature is useful when there is no need for the maximal brightness and helps to save power.

1. Press **Options** for three seconds.
2. Go to br.
3. Using the arrow keys, define the restriction level.

4.1.5 SYSTEM PARAMETER 5 – CURVE (CN)

NOTE Munters recommends leaving this parameter at the default setting. Change the setting only if the lights flicker.

To define the curve:

1. Press Options for three seconds.
2. Go to Cn.
3. Choose (2) (default setting) or (1).

NOTE After changing the curve, recalibrate the [Minimum Light Calibration](#).

4.2 Bright Mode

The Bright mode raises the light intensity to the maximum value set in the "br" parameter. The light remains at this level for 20 minutes. The feature is useful, for example, when a farmer needs to have the light on for a specific period of time in the poultry house. After that time period, the light dims gradually down to the previous value.

- After turning on the lights, press the arrow buttons to increase or decrease the time that the lights remain on.

NOTE The system returns to the previous mode, at the point where it left off.

To keep the brightness at this level, set the unit to Manual Dim Mode.

4.3 Manual Dim Mode

Pressing "Manual Dim" enters the device into "Manual Dim" mode. The display changes and indicates the voltage percentage value for that channel. Manual Dim is used to override the Auto Mode settings.

In manual mode the user changes the light brightness by pressing the UP and DOWN arrow keys.

4.4 Auto Mode

Pressing the "Auto" button enables connecting the RLED 2.0 to a controller. There are two ways to connect the RLED 2.0 to a controller:

- Via an analog output card 0-10 VDC (All Munters Controllers)
- Via a communication card (Platinum Pro Controllers only)

CAUTION *Connect the RLED 2.0 to a controller using one option only! Connecting the RLED 2.0 using both methods together results in faulty light levels.*

- Refer to System Parameter 2 - Address (Ad), page 9 to define the controller connection.
- Refer to Configuring the Channel Levels, page 14 for information of connecting the unit to a controller.

4.5 Performing a Cold Start

Perform Cold Start to return the RLED 2.0 to its default parameters:

1. Press the Channel A arrow buttons and the internal reset button (located on the CPU card).
2. Release the reset button.

Cold appears on the screen.

NOTE To check the software version, press the RESET button.

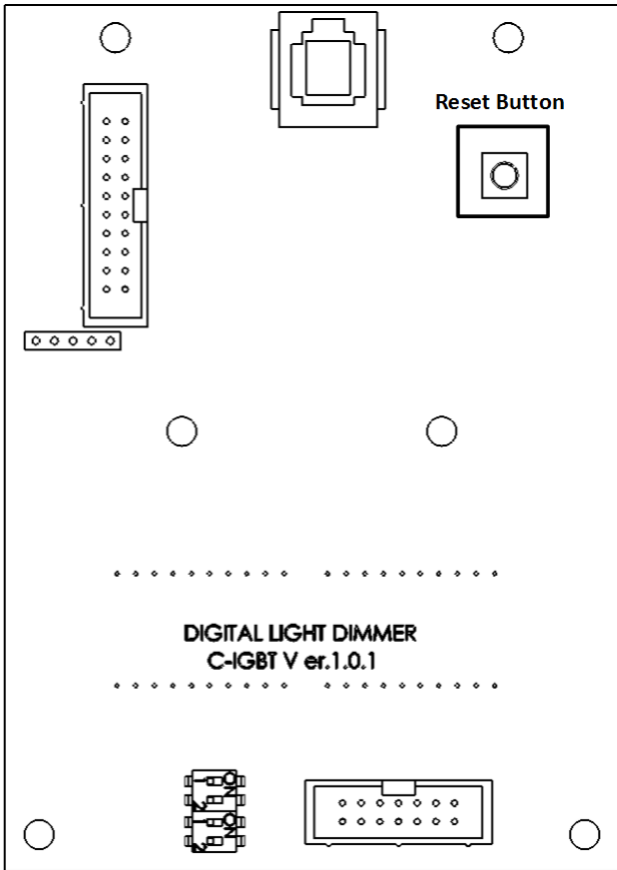

Figure 3: Reset Button Location

5 Installation

WARNING! ONLY an authorized electrician may install the RLED 2.0. Power must be disconnected to avoid electrical shock and damage. To avoid exposing the RLED 2.0 to harmful gases or high humidity, it is recommended to install it in the service room.

NOTE Installation Category (Over voltage Category) II

CAUTION The wires that supply power to the RLED 2.0 schematics also supply power to the light. The cross section of the copper cable must not be less than 10 mm². Verify that the correct load wires are in use.

CAUTION The COM connection for communications is not the shield wire. The COM, RX and TX wires must connect to each other at all controllers.

1. Mount the RLED 2.0 on the wall, using the four supplied screws through the mounting holes.
2. Place the required cables through the cable holders at the bottom of the unit. Connect the wires according to the wiring diagrams (see below).
3. To connect the "0 - 10" volt DC wire to the controller, use two conductor #18 - #22 gauge cable. Connect the minus (-) to the Common terminal on the controller terminal block, and the plus (+) to terminal #4 (0 - 10 volt output).
4. Close the RLED 2.0 enclosure lid carefully and tightly.
5. Use RTV silicon or an equivalent sealant to seal the cable holders.
6. After installation has been completed, operate the RLED 2.0 (and the controller, if connected) for a few hours and check for proper operation.
7. Continue the installation as detailed in the following sections.
 - RLED 2.0 Wiring Diagram
 - Configuring the Channel Levels
 - Environmental Protection

CAUTION To ensure proper Light Dimmer operation, do not connect any inductive devices to the output (for example transformers, reactors, chokes).

5.1 RLED 2.0 Wiring Diagram

The following diagrams show how to connect the RLED 2.0 to a:

- Power source
- Lighting

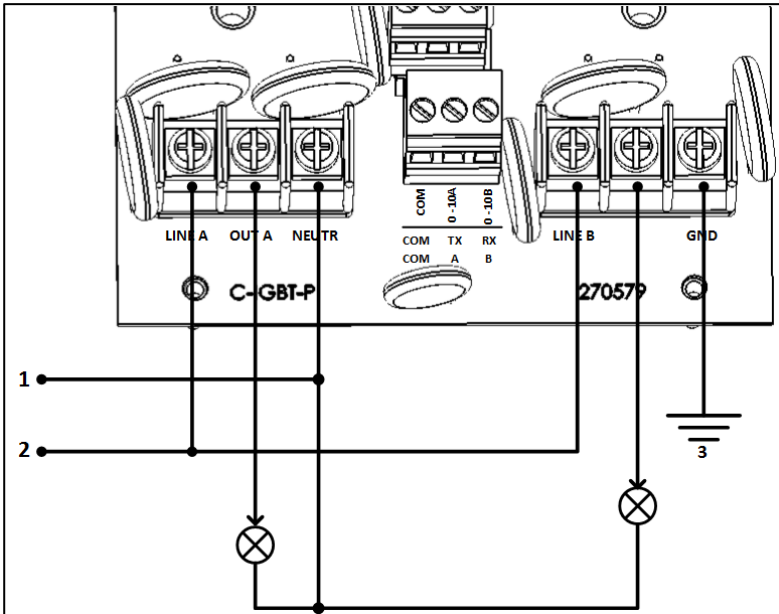

Figure 4: Single Phase Wiring

Figure 5 key

1	Neutral
2	Line
3	Safety ground

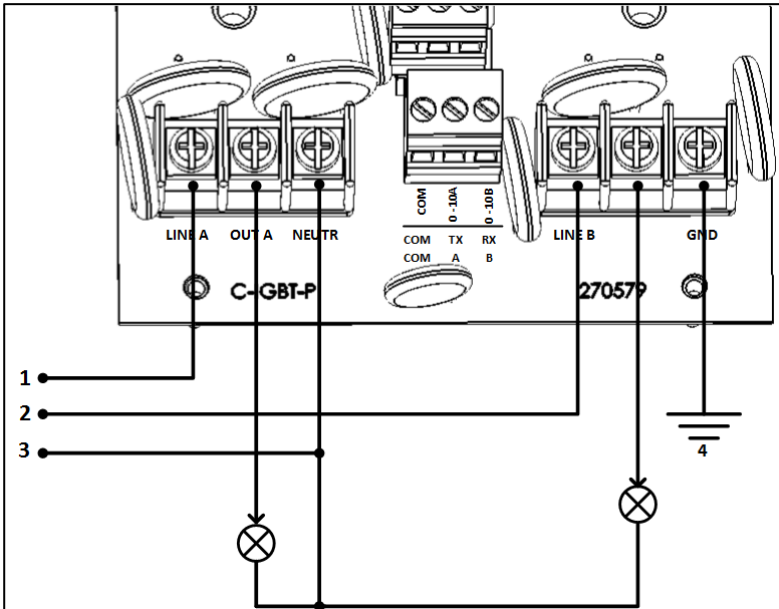

Figure 5: Dual Phase Wiring

Figure 6 key

1	Line A
2	Line B
3	Neutral

Figure 6 key

4 Safety ground

5.2 Configuring the Channel Levels

The following sections detail how to configure the channel levels.

- Using an Analog Output Card
- Using a Communication Card

5.2.1 USING AN ANALOG OUTPUT CARD

NOTE Verify that parameter "Ad" is set to "0" (refer to System Parameter 2 - Address (Ad), page 9).

1. Connect the 0 - 10 VDC (+) and COM (-) wires from the external device to terminal ports "0 10V A", "0-10V B" and COM (Figure 6).

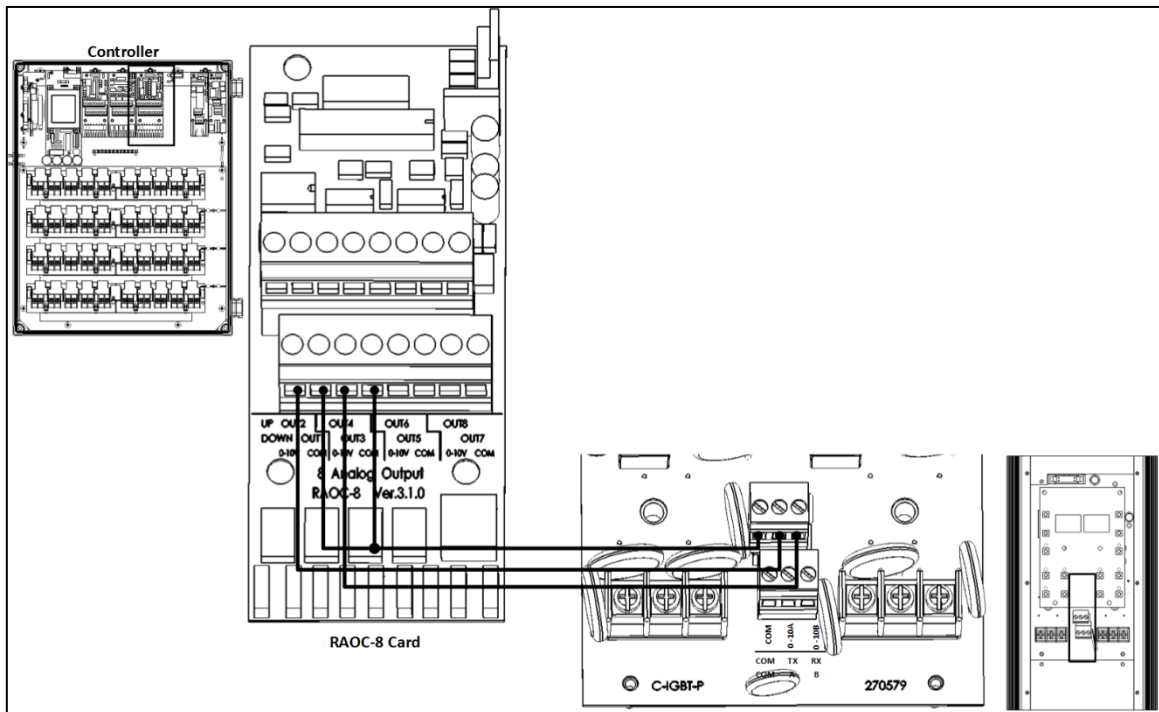

Figure 6: RAOC-8 (Analog Output) to LLED 2.0 Wiring Diagram

2. To control both channels simultaneously, short "0-10V A" and "0-10V B".
3. To configure the channel levels go to the:
 - Analog output table (Platinum, Platinum Pro and Super Guard)
 - System parameters (AC-2000)

5.2.2 USING A COMMUNICATION CARD

1. Lift the top board.
2. On the board are four dipswitches. Set the dipswitches to the required setting.

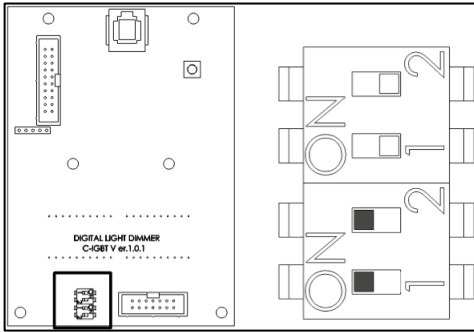

Figure 7: RS-232 Dipswitches

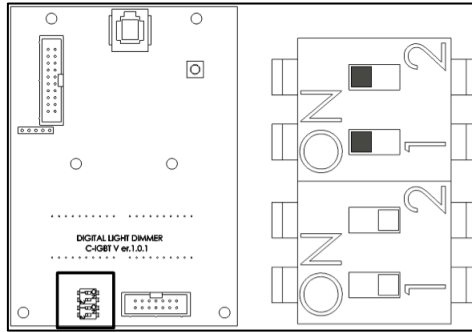

Figure 8: RS-485 Dipswitches

3. Connect the RLED 2.0 to a Platinum Pro communication card.

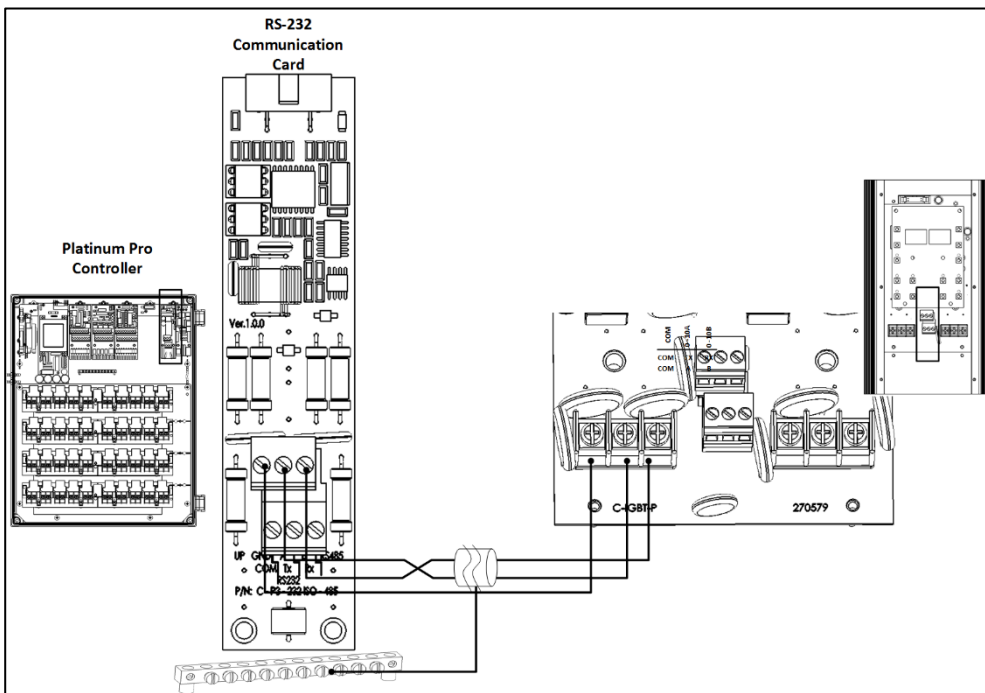

Figure 9: RS-232 Wiring (example)

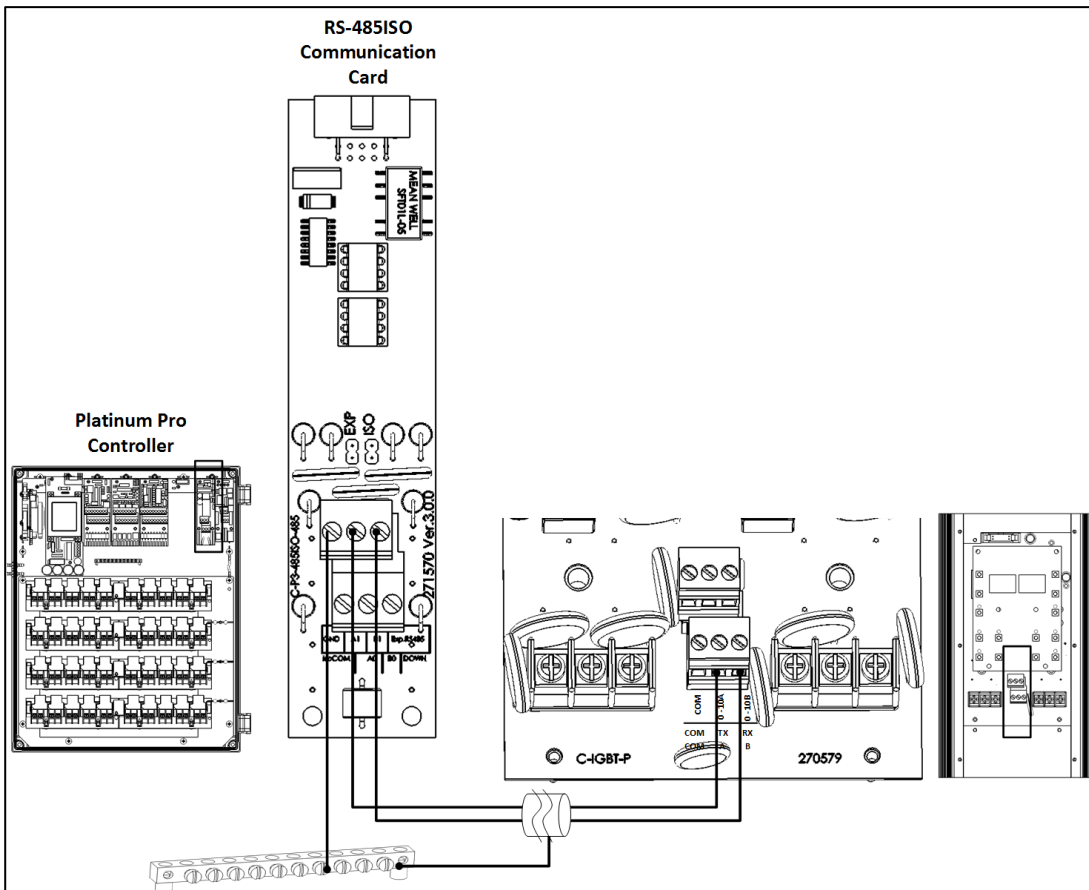

Figure 10: Isolated RS-485 Wiring (example)

NOTE Verify that parameter "Ad" is set to "1 - 8" (refer to System Parameter 2 - Address (Ad), page 9).

4. Configure the channels. There are two numbering options:

- Different numbers to each channel, with up to eight different channels (when using multiple RLED 2.0 units).
- Same number for more than one channel if you require the same behaviors from these channels.

For example, two RLED 2.0 units can control four channels using the communication line:

- 1st channel (A1) #1: 20%
- 2nd channel (A2) #2: 10%
- 3rd channel (B1) #2: 10% (same as A2)
- 4th channel (B2) #3: 90%

5.3 Environmental Protection



Recycle raw materials instead of disposing as waste. The controller, accessories and packaging should be sorted for environmental-friendly recycling. The plastic components are labeled for categorized recycling.

6 Troubleshooting

#	Problem Description	Troubleshooting
1	Power is connected, yet LEDs are off.	<ol style="list-style-type: none"> 1. Check the power. 2. Check the main fuse F3. 3. Using a DVM, test the +5 and COM test points (refer to Figure 12). 4. Check flat cable connection.
2	Power is ON, but there is no Output when working in "AUTO" mode with "0-10V" control voltage.	Make sure the "+" and "COM" of "0-10V" cable is connected correctly. Set 5V from controller and measure this value at the RLED 2.0 terminal.
3	Power is ON, but there is no Output when working in "AUTO" mode with communication lines.	<ol style="list-style-type: none"> 1. Check the dipswitches and ensure that they are set correctly (refer to Figure 8 and Figure 9, page 15). 2. Check the wiring.
4	The lights blink when working at low voltage levels.	<ol style="list-style-type: none"> 1. Make sure there is no inductive devices (for example transformers and power coils) integrated into the electrical load system. 2. In Options > Cn, change the Cn setting. This step requires recalibration. Refer to System Parameter 1 - Minimum Light Calibration (bu), page 8) 3. Apply Ignition Pulse.
5	Light is always at maximum brightness or you can't change the brightness.	Contact technical support.

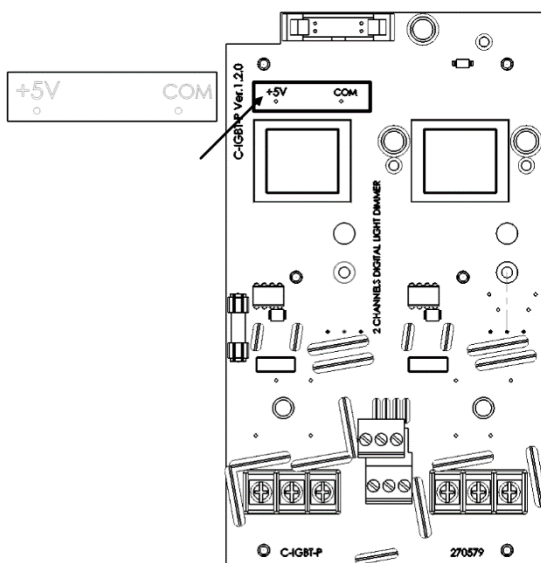

Figure 11: +5V Test Point

7 Warranty

Warranty and technical assistance

Munters products are designed and built to provide reliable and satisfactory performance but cannot be guaranteed free of faults; although they are reliable products they can develop unforeseeable defects and the user must take this into account and arrange adequate emergency or alarm systems if failure to operate could cause damage to the articles for which the Munters plant was required: if this is not done, the user is fully responsible for the damage which they could suffer.

Munters extends this limited warranty to the first purchaser and guarantees its products to be free from defects originating in manufacture or materials for one year from the date of delivery, provided that suitable transport, storage, installation and maintenance terms are complied with. The warranty does not apply if the products have been repaired without express authorisation from Munters, or repaired in such a way that, in Munters' judgement, their performance and reliability have been impaired, or incorrectly installed, or subjected to improper use. The user accepts total responsibility for incorrect use of the products.

The warranty on products from outside suppliers fitted to RLED 2.0, (for example antennas, power supplies, cables, etc.) is limited to the conditions stated by the supplier: all claims must be made in writing within eight days of the discovery of the defect and within 12 months of the delivery of the defective product. Munters has thirty days from the date of receipt in which to take action, and has the right to examine the product at the customer's premises or at its own plant (carriage cost to be borne by the customer).

Munters at its sole discretion has the option of replacing or repairing, free of charge, products which it considers defective, and will arrange for their despatch back to the customer carriage paid. In the case of faulty parts of small commercial value which are widely available (such as bolts, etc.) for urgent despatch, where the cost of carriage would exceed the value of the parts, Munters may authorise the customer exclusively to purchase the replacement parts locally; Munters will reimburse the value of the product at its cost price.

Munters will not be liable for costs incurred in demounting the defective part, or the time required to travel to site and the associated travel costs. No agent, employee or dealer is authorised to give any further guarantees or to accept any other liability on Munters' behalf in connection with other Munters products, except in writing with the signature of one of the Company's Managers.

WARNING: In the interests of improving the quality of its products and services, Munters reserves the right at any time and without prior notice to alter the specifications in this manual.

The liability of the manufacturer Munters ceases in the event of:

- dismantling the safety devices;
- use of unauthorised materials;
- inadequate maintenance;
- use of non-original spare parts and accessories.

Barring specific contractual terms, the following are directly at the user's expense:

- preparing installation sites;
- providing an electricity supply (including the protective equipotential bonding (PE) conductor, in accordance with CEI EN 60204-1, paragraph 8.2), for correctly connecting the equipment to the mains electricity supply;
- providing ancillary services appropriate to the requirements of the plant on the basis of the information supplied with regard to installation;
- tools and consumables required for fitting and installation;
- lubricants necessary for commissioning and maintenance.

It is mandatory to purchase and use only original spare parts or those recommended by the manufacturer.

Dismantling and assembly must be performed by qualified technicians and according to the manufacturer's instructions.

The use of non-original spare parts or incorrect assembly exonerates the manufacturer from all liability.

Requests for technical assistance and spare parts can be made directly to the nearest Munters office. A full list of contact details can be found on the back page of this manual.

Munters Israel

18 HaSivim Street
Petach-Tikva 49517, Israel
Telephone: +972-3-920-6200
Fax: +972-3-924-9834



www.munters.com

Australia Munters Pty Limited, Phone +61 2 8843 1594, **Brazil** Munters Brasil Industria e Comercio Ltda, Phone +55 41 3317 5050, **Canada** Munters Corporation Lansing, Phone +1 517 676 7070, **China** Munters Air Treatment Equipment (Beijing) Co. Ltd, Phone +86 10 80 481 121, **Denmark** Munters A/S, Phone +45 9862 3311, **India** Munters India, Phone +91 20 3052 2520, **Indonesia** Munters, Phone +62 818 739 235, **Israel** Munters Israel Phone +972-3-920-6200, **Italy** Munters Italy S.p.A., Chiusavecchia, Phone +39 0183 52 11, **Japan** Munters K.K., Phone +81 3 5970 0021, **Korea** Munters Korea Co. Ltd., Phone +82 2 761 8701, **Mexico** Munters Mexico, Phone +52 818 262 54 00, **Singapore** Munters Pte Ltd., Phone +65 744 6828, **South Africa and Sub-Sahara Countries** Munters (Pty) Ltd., Phone +27 11 997 2000, **Spain** Munters Spain S.A., Phone +34 91 640 09 02, **Sweden** Munters AB, Phone +46 8 626 63 00, **Thailand** Munters Co. Ltd., Phone +66 2 642 2670, **Turkey** Munters Form Endüstri Sistemleri A.Ş, Phone +90 322 231 1338, **USA** Munters Corporation Lansing, Phone +1 517 676 7070, **Vietnam** Munters Vietnam, Phone +84 8 3825 6838, **Export & Other countries** Munters Italy S.p.A., Chiusavecchia Phone +39 0183 52 11

©Munters, 2018