

ATLAS PROFESSIONAL COLLECTION

SAKKARA BASIN - 50CM 2 TH



Product Code	SKWH50BA2
Weight (Kg)	9.5
Material	Vitreous China
Tap holes	2
Fixings	Bracket - BRACK / Fixing bolts - FBWB
Extras	Bottle trap - BOTRAPCH / Waste - TPOPRNEW / TPOPUNS
Suitable Pedestals	Full ped - SKWHPE Half ped - NLGWSPE

Key features:

- CE Compliant
- Internal overflow
- Clean design
- Chrome effect overflow ring

Description:

Simple styling never goes out of fashion.

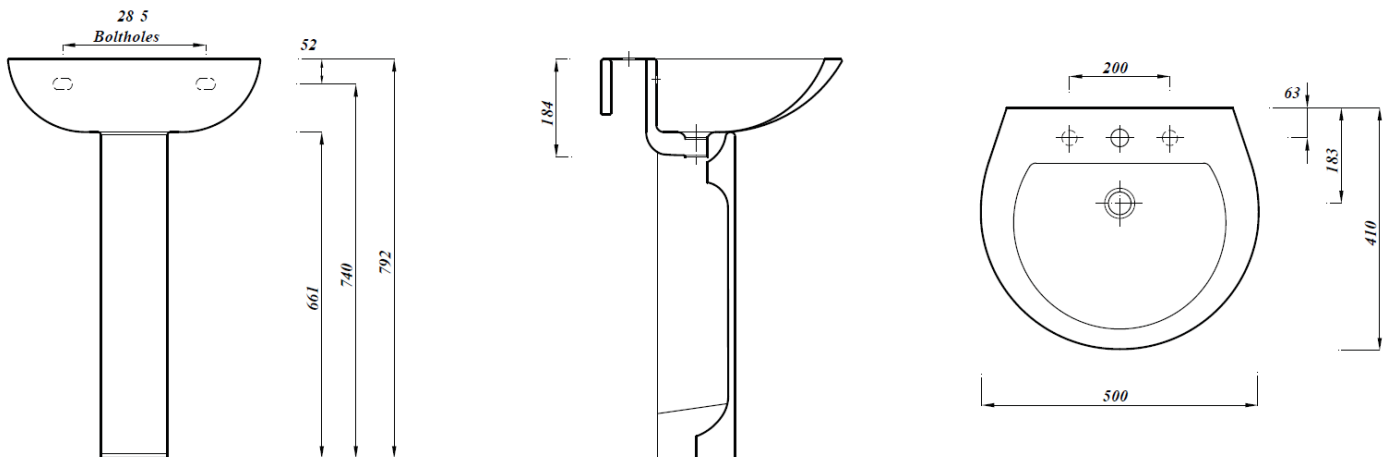

All dimensions are approximate and subject to normal ceramic variation. Although every effort is made not to change the above product specification, Lecico reserve the right to do so without prior notification if necessary. Lifetime ceramic guarantee against manufacturers defects. Full information on guarantees available upon request.