

Atlas

VANITY 53CM BASIN 2TH



Product Code	ASWHVBA2
Weight (Kg)	8.4
Material	Vitreous China
Tap holes	2
Fixings	Includes cutting template
Extras	Bottle trap - BOTRAPCH / Waste - TPOPRNEW

Key features:

- UKCA compliant
- Oval design
- Internal overflow
- Lifetime ceramic guarantee*

Description:

Vanity basins are designed for use with solid or composite, natural or man-made worktops. Ideal for contemporary bathrooms or commercial settings.

Overflow is opposite tap (hidden in picture).

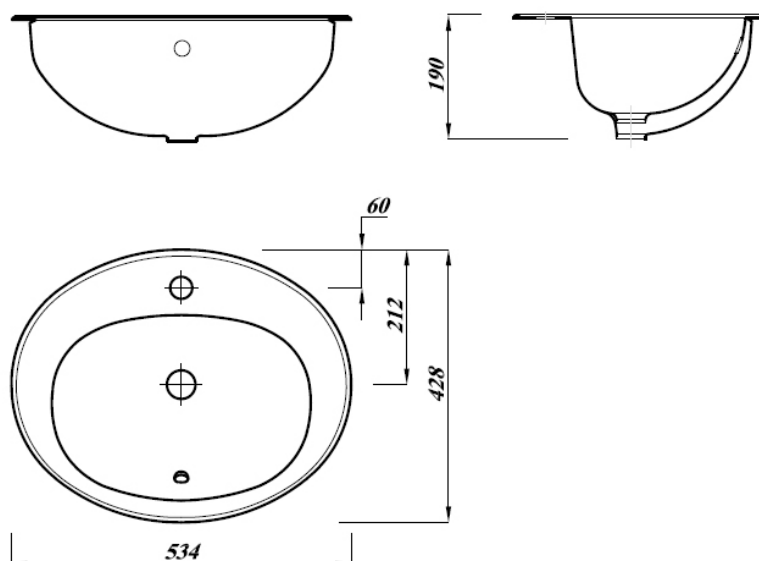

All dimensions are approximate and subject to normal variation. Although every effort is made to change the above product specification, Lecico reserve the right to do so without prior notification if necessary. All guarantees are against manufacturers defects. Full information on guarantees available upon request.