

Delta Flex and Vibro Flex 7400



Stubble cultivators with rigid or vibrating tines

Stubble cultivation



What is obtained by correct stubble cultivation?

Incorporation of straw and field residues

- Quick decomposition due to the mixing of both straw and plant residues with the soil
- Utilizing the moisture in the soil just after harvest
- Establish an optimal climate for microbes to work in

Establishment of a stale seedbed for germination of weed seeds

- Shallow cultivation directly after harvest will encourage lost seeds and weed seeds to germinate
- Seedbed preparation for establishing intermediate crops such as mustard, oil radish etc.
- No slug nutrition

Preparation of a seedbed in mulch tillage systems

- Creation of a seedbed before the drilling operation
- Breaking down the soil pan allows moisture and nutrients access to the root zone.
- Cultivation depth in relation to the amount of residues on the field

Level out wheel marks

- Working depth can be adjusted to suit particular depth of wheel tracks
- Improved seed placement and germination is obtained
- Improved boom stability during spraying increases capacity
- Reduced tractor operator fatigue

Weed control

- Dry out weeds by pulling them to the soil surface
- Possible to set the working depth according to which type of weed seeds are to be eliminated



Common platform



VF 7450 HT

Common platform offers flexibility

Main advantages:

- Reliable heavy duty construction
- Blockage-free operation through large frame clearance and tine spacing
- Safe access for wearing part replacement when wings folded to vertical
- Wing pressure system allows machine to follow field contours
- Simple adjustment of the working depth by pin/hole system
- Changing the working depth has no effect on the levelling system settings after basic adjustment
- Transport wheels at the rear for safe road transport
- Reduced soil compaction on headlands through wide profile transport tyres
- Modular frame construction allows later conversion from mounted to trailed version
- The common platform allows working depths up to 25 cm

Specification (fully mounted)

- Rigid versions in 2,5 – 3,0 - 3,5 - 4,0 m
- Hydraulic folding in 2 sections for 4,0 - 5,0 – 6,0 m versions (Vibro Flex 7400), 4,0 – 5,0 m versions (Delta Flex)

- Under frame clearance of 800 mm
- 100x100 mm box sections
- Symmetrical tine pattern
- 2,5 m transport width for hydraulic folding versions
- Automatic hydraulic wing lock system
- Hydraulic pressure on the wings in work
- Category 3 attachment

Specification (trailed)

- Foldable versions in 4,0 – 5,0 – 6,0 – 7,0 m
- Hydraulic folding in 2 sections
- Under frame clearance of 800 mm
- 100x100 mm box sections
- Symmetrical tine patterns
- 3,0 m transport width
- Automatic hydraulic wing lock system
- Hydraulic pressure on the wings during work
- Swivel hitch attachment Cat. 3 with telescopic drawbar
- Wide flotation tyres (15.0/55-17)
- Front wheels
- Category 2 / 3 attachment
- Wide low flotation tires (15.0/55-17)
- Front wheels



Symmetrical tine pattern.



Safe road transport. DF 5000 HT.



Automatic hydraulic wing lock system.



DF 4000 HT

Delta Flex



Rigid tine stubble cultivator

Main advantages:

- Rigid tines ensure an even working depth
- Working depths from 6 - 25 cm in one pass
- Fitted with wing shares a full cut across the entire working width is achieved
- Without wing shares fitted, deeper loosening down to 25 cm is possible in one pass
- Optimal mixing of straw and residues is the result of the special curved stems, which encourage a rolling soil action
- Release force of 400 kg on the tip of the point
- High release clearance of 25 cm
- Easy conversion from shearbolt to non-stop version

Benefit for the user:

- Delta Flex is a heavy duty cultivator for conventional stubble cultivation and mulch tillage
- Possibility of shallow cultivation with a full width cut or deeper tillage up to 25 cm

- The special design of the Delta Flex fine ensures optimal cutting and mixing of soil and residues for a quick decomposition process

Specification

- 3 rows of rigid C-shaped tines
- Non-Stop or shearbolt tine overload system
- 310 mm tine spacing
- 80 mm point and 350mm wing shares
- Working depths from 6 – 25 cm in one pass
- High quality shares made from hardened boron steel
- Fully mounted version in 2,5 – 3,0 – 3,5 - 4,0 - 5,0 m working widths
- Trailed version in 4,0 – 5,0 – 6,0 - 7,0 m working widths
- Front wheels standard on widths from 4,0 – 7,0 m



C-shaped Delta Flex tine.



Optimal mixing of soil and residues.

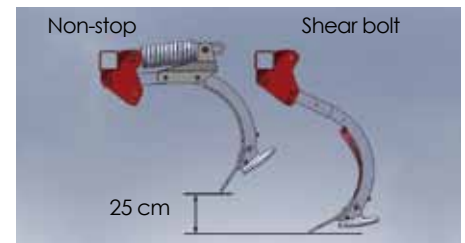

High ground clearance during release of the stem.



Vibro Flex 7400



VF 7440 H

Vibrating tine stubble cultivator

Main advantages:

- The constantly-vibrating Vibro Flex tines leave an open soil structure
- An extra crumbling effect is obtained, as the soil breaks up in the natural fracture lines
- 4 rows of tines for a more intensive mixing of field residues with soil in one pass
- Heavy duty VFM-spring with built-in backwards and sideways overload protection
- Constant working depth as share point always operates directly under the fine flex point
- Working depths from 6 – 15 cm in one pass and up to 25 cm in the following pass
- Wide range of heavy duty high quality shares

Benefit for the user:

- All-round cultivator for both conventional stubble and mulch tillage operations
- Optimal cultivation and mixing in working depths up to 15 cm.
- Low horsepower requirements combined with fuel savings through use of vibrating tines
- Improved water passages both up and downwards
- Low maintenance requirements

Specification

- 4 rows of genuine Kongskilde Vibro Flex Mixing tines
- 11 cm reversible ultra mulching shares or 26 cm wide mixing shares
- 230 mm tine spacing
- 800 mm frame clearance
- Symmetrical tine pattern
- Fully mounted version in 2,5 – 3,0 – 3,5 – 4,0 – 5,0 – 5,8 m working widths
- Trailed version in 4,0 – 5,0 – 5,8 – 7,0 m working widths
- Front wheels standard on widths from 5,0 – 7,0 m



Vibro Flex Mixing tine (VFM).



4 rows of tines for a more intensive mixing of soil and field residues.

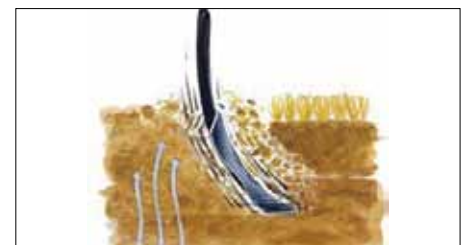

Constantly-vibrating tines.



VF 7450 HT

Equipment for Delta Flex and Vibro Flex 7400



DF 3000

Levellers

Intensive levelling of the soil after the cultivator fine section is the premium criterion for quality reconsolidation. For the Delta Flex and Vibro Flex 7400 ranges Kongskilde offers 2 options for levelling.

Disc leveller

- Constant and blockage-free rotation.
- One-step depth adjustment together with the cultivation depth
- Frame connection via Kongskilde VTH spring, acting as suspension
- Further mixing of plant residues with soil for quicker decomposition.
- Mounted in sections, with 2 Ø460mm notched discs on each section.
- Spindle depth adjustment

Hockey stick leveller

- Cheaper alternative to disc leveller.
- 2 hockey stick fines connected to VTH spring
- Levelling the soil after the cultivator fines enabling rear roller to leave a level surface.

Rear rollers

For Delta Flex and Vibro Flex 7400 Kongskilde offers 3 types of rear roller. Consistent soil compaction after cultivation ensures a fast germination of weed seeds and lost grains. Good contact between soil and plant residues provides optimum conditions for quick decomposition.

Max Pack

- Steel ring roller for firm reconsolidation.
- Perfect choice of roller for heavy soil conditions, where crushing of clods is also requested.
- Ø550 mm notched steel rings at 12,5 cm spacing.
- Compaction achieved not only on the top of the soil, but the angled shoulders of the rings also create some side-packing inside the soil.
- Load is distributed between the top and the lower soil layers.
- Recommended for trailed models.

Vibro Pack

- Newly-developed Vibro Pack spring roller with unique function
- Utilizes the special technique and advantages of the vibrating Kongskilde cultivator springs.
- Versatile roller for use in medium to heavy soil types
- Besides packing, the Vibro Pack also creates a crumbling effect in the soil
- Special vibrating springs connected in pairs.
- 2 springs connected ensures constant rotation of the Ø 570 mm roller in all conditions.
- Flexibility in the springs ensures an even compaction across the full working width
- Packing in stripes at 12,5 cm Spacing, leaving the soil open for moisture absorption.



Disc leveller.



Hockey stick leveller.



Max Pack.



Vibro Pack.



VF 7450 HT

Crumble roller

- Well-known Ø550 mm diameter crumble roller
- Good choice in most soil types, with special advantage of constant rotation.
- Cost-effective alternative to Max Pack and Vibro Pack rollers; in many cases a substantial packing and crumbling effect is achieved.

Shares

- Wide range of genuine high quality shares for Delta Flex and Vibro Flex 7400 to suit different applications.
- Made in hardened boron steel for a long lifetime.

Front wheels

- Heavy duty front wheels are standard on all trailed cultivators (except VF 4,0 m).
- Spindle adjustment.
- Provide support and prevent nose-diving

Front disc section (Vibro Flex 7400)

To cut and separate plant residues (maize, oil seed rape etc) an independent disc section can be used in front of the cultivator section.

- Notched discs chop residues, thereby improving the passage of material through the cultivator, as well as adding to mixing effect.
- Ø460 mm discs attached to the front frame by Kongskilde VFM springs, acting as suspension.
- Depth control independent from cultivator tines



Crumble roller.



Front wheel.



Front disc section - Vibro Flex 7400.

Vibro Flex 7400



Delta Flex

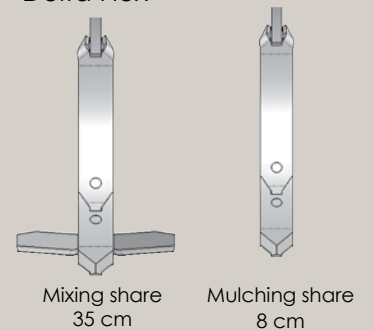



Technical Data

Delta Flex

	Model	Work Width	No. of tines	Tine spacing	Transport width	Cat.	Weight incl. crumble roller	Front wheels	Power requirements hp
	Rigid								
	DF 2500	2.5 m	7	33 cm	2.5 m	2	1450 kg	-	90 - 125
	DF 3000	3.0 m	9	33 cm	3.0 m	2	1650 kg	-	120 - 175
	DF 3500	3.5 m	11	31 cm	3.5 m	2	1875 kg	-	140 - 190
	DF 4000	4.0 m	13	31 cm	4.0 m	2	2100 kg	-	160 - 225
	Hydr. folding								
	DF 4000 H	4.0 m	13	31 cm	2.5 m	3	2300 kg	10.0/80-12	160 - 225
	DF 5000 H	5.0 m	15	33 cm	2.5 m	3	2800 kg	10.0/80-12	200 - 275
	Hydr. Folding trailed								
	DF 4000 HT	4.0 m	13	31 cm	3.0 m	3	3200 kg	10.0/80-12	160 - 225
	DF 5000 HT	5.0 m	15	33 cm	3.0 m	3	3700 kg	10.0/80-12	200 - 275
	DF 6000 HT	6.0 m	19	31 cm	3.0 m	3	4100 kg	10.0/80-12	240 - 325
	DF 7000 HT	7.0 m	21	33 cm	3.0 m	3	4500 kg	10.0/80-12	280 - 375

Vibro Flex 7400

	Model	Work Width	No. of tines	Tine spacing	Transport width	Cat.	Weight incl. crumble roller	Front wheels	Power requirements hp	
	Rigid									
	VF 7425	2.5 m	11	23.5 cm	2.5 m	2	1300 kg	-	75 - 90	
	VF 7430	3.0 m	13	23.5 cm	3.0 m	2	1500 kg	-	100 - 130	
	VF 7435	3.5 m	15	23.5 cm	3.5 m	2	1650 kg	-	115 - 150	
	VF 7440	4.0 m	17	23.5 cm	4.0 m	2	1850 kg	-	130 - 170	
	Hydr. folding									
		VF 7440 H	4.0 m	17	23.5 cm	2.5 m	3	2050 kg	Optional	130 - 170
		VF 7450 H	5.0 m	21	23.5 cm	2.5 m	3	2500 kg	24x8.00-14.5 or 10.0/80-12	160 - 210
	VF 7460 H	5.8 m	25	23.5 cm	2.5 m	3	2800 kg	24x8.00-14.5 or 10.0/80-12	200 - 250	
	Hydr. Folding trailed									
	VF 7440 HT	4.0 m	17	23.5 cm	3.0 m	3	3000 kg	Optional	130 - 170	
	VF 7450 HT	5.0 m	21	23.5 cm	3.0 m	3	3.000 kg	10.0/80-12	160 - 210	
	VF 7460 HT	5.8 m	25	23.5 cm	3.0 m	3	3700 kg	10.0/80-12	200 - 250	
	VF 7470 HT	7.0 m	29	23.5 cm	3.0 m	3	4100 kg	10.0/80-12	240 - 290	
	Hydr. folding trailed with front discs									
	VF 7440 HT FD	4.0 m	17	23.5 cm	3.0 m	3	3380 kg	-	140-180	
	VF 7450 HT FD	5.0 m	21	23.5 cm	3.0 m	3	3890 kg	Optional in size 24x8.00-14.5	170-220	
	VF 7460 HT FD	5.8 m	25	23.5 cm	3.0 m	3	4240 kg	Optional in size 24x8.00-14.5	210-260	
	VF 7470 HT FD	7.0 m	29	23.5 cm	3.0 m	3	4750 kg	Optional in size 24x8.00-14.5	250-300	

101001585 EXP/GB/Stubble cultivation/BO/0412

Subject to be changed without notice.



Kongskilde Industries A/S

Tel. +45 33 68 35 65

mail@kongskilde.com

www.kongskilde.com